

Grandview

Telescopic motorized projector lift Instruction Manual

Model: GPXD/GPXC42 SERIES

Grandview

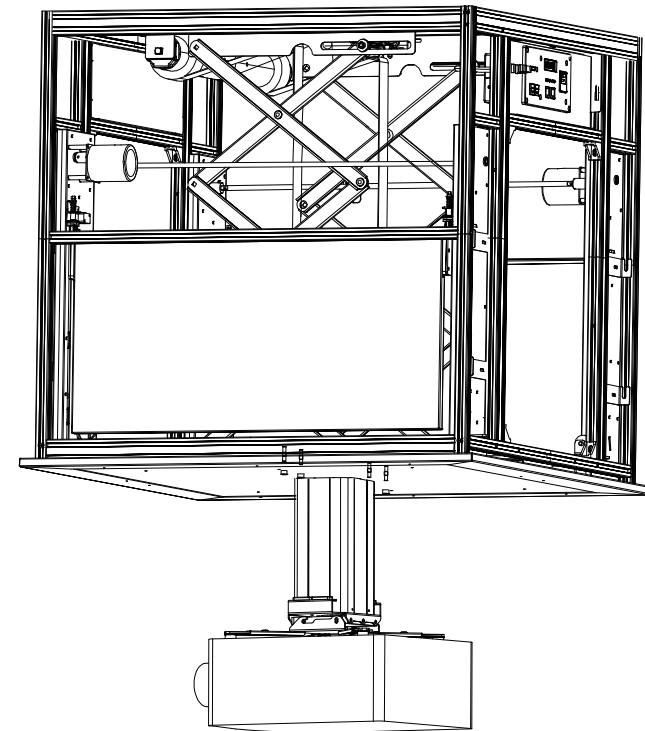

Guangzhou Grandview Crystal Screen Co.,Ltd.
Guangzhou Grandview Creative Technology Co., Ltd.
No.43,Guomao Road South , Hualong Town,Panyu District ,
Guangzhou City ,GuangDong Province,China.
<http://www.grandviewscreen.com>
Tel:(86)-20-84899499



Troubleshoot



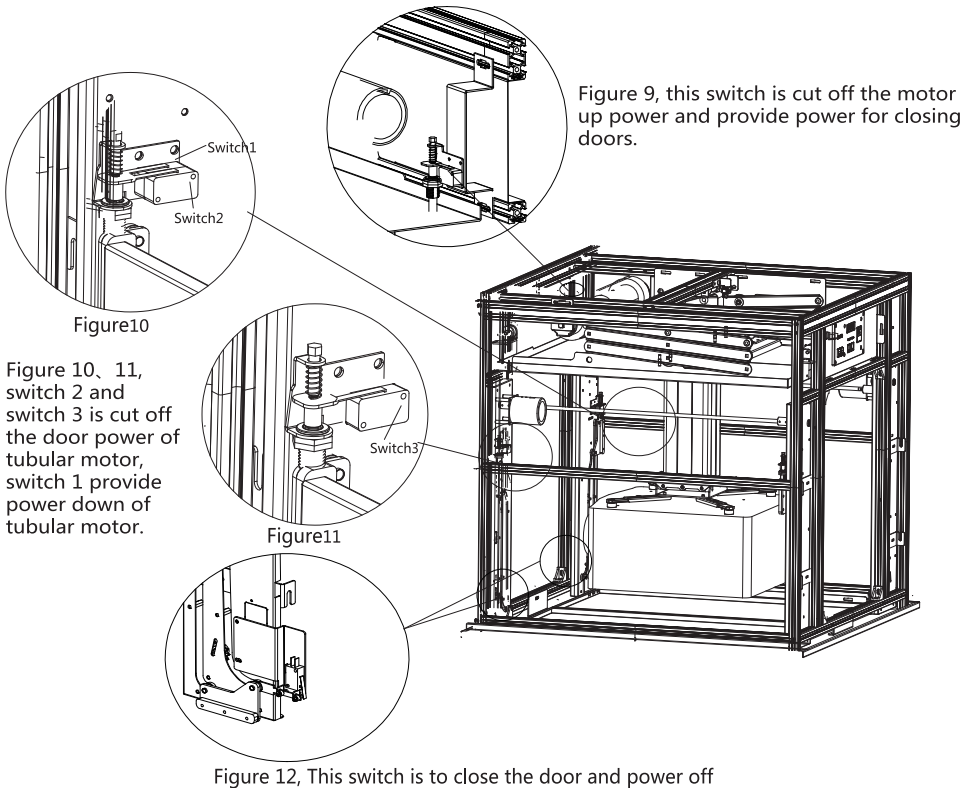

This product is designed to be used for many years without failure, and many problems are caused by simple little things. If you find a problem, please check the simple fix list below. If the problem persists, please contact an authorized dealer.

Problem	REASON	Solutions
HDMI screen failure	①HDMI bad quality or dust got inside	①Replace the new HDMI cable or Blow off the HDMI head dust
	②The crystal head of the network cable box is not grounded	②Connect the crystal head of the network cable box to the ground
door close failure	①Deformation of the door close lever switch bracket	①Check if there is any deformation of the door-closing switch bracket, if yes, please fix the bracket, (Figure 9)
	②The door close lever switch is broken	② replace the new switch or clockwise to adjust the motor green button 1~2 turns
noisy when door closing	Touching the decorative frame or side sealing plate when closing the door	Decorative frame or side seal plate is not installed right.
Lift don't work	Motor overheat protection	Wait for the motor to cool down
positioning mislocation	Circuit board problem	Contact with manufacturer or dealers.



Caution

- Please ensure the installation ceiling be secure enough to avoid falls,.The loading capacity must be 4 times of the projector lift and the projector.
- Please tighten all the screws and check whether it become loose regularly,to ensure safety use.
- Please do some regular maintenance.
 - When dirty mark there,please gave the lift a polish with a soft duster.
 - When dust there,please remove with soft brush.
- Kindly suggest a specialist to manage this device,then ensure security and smooth use.
- Please ensure the lift up and down via Remote control,no pulling with hands.
- Always retract the lift to the ceiling after use.
- Ensure the power outlet is connecting with grounding wire.
- There is no need to add the lubricant to the motor.Do not regulate the motor by yourself,the motor is already in the right position before delivery,Please call a specialist to help you on this when it isin needed.

 Please do read the caution,incorrect operation will cause accident and productdamage.	 Please install the lift in the place withstronger loading capacity,other wiseaccident may happen and falling riskthere.
 When the lift is fully lowered,the bottom of the lift should be no less than 1.8 metersaway from the ground to avoid being touchedby children.	 Do not take apart the lift by yourself, Please call a specialist to help you onthis when Fix and regulating job in needed
 Please always retract the lift to the ceilingafter use,prevent the dust entering.	

Users are not allowed to disassemble and replace parts at will. If there is a fault, they must contact the after-sales service department for repair; if the function structure is changed, no notice will be given, the product shall prevail!

Component

GPXD/XC42 Series

- ① Strap
- ② Control panel
- ③ Tubular motor
- ④ Scissor arm
- ⑤ Electric double door (GPXD series)
- ⑥ Ceiling decorative frame
- ⑦ Fixed telescopic
- ⑧ Projector mounting feet
- ⑨ Projector cage (GPXC series)

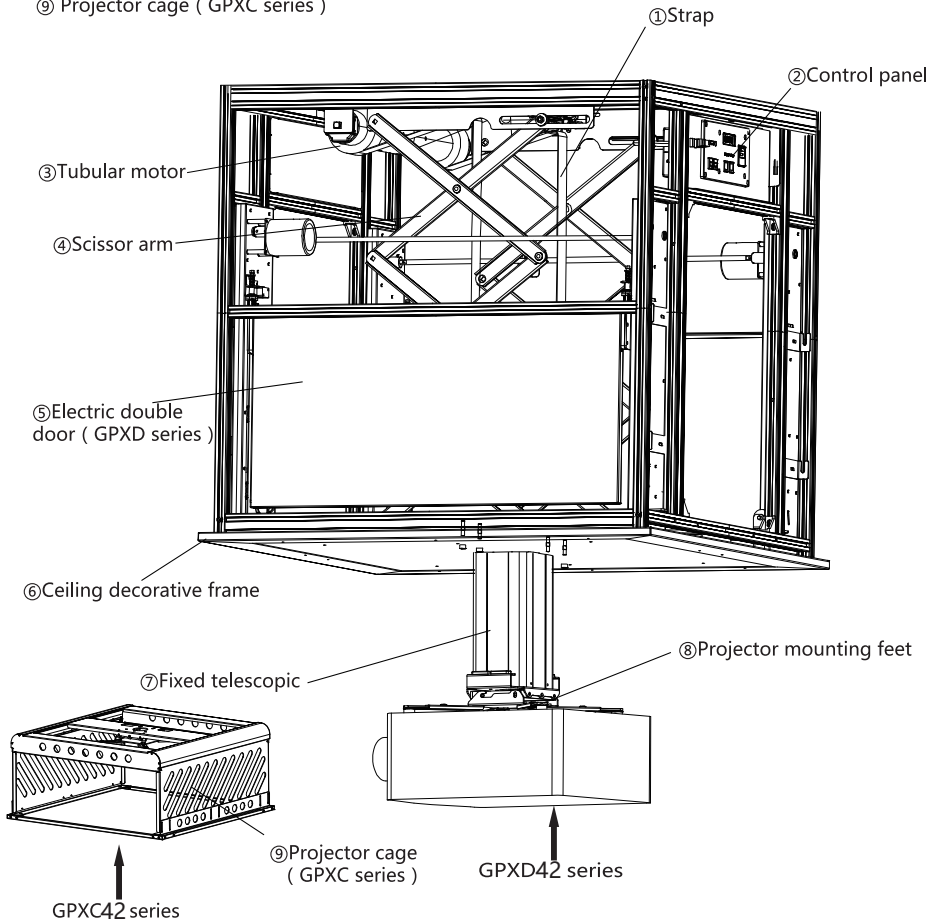

Note The difference of GPXD/GPXC series: GPXD is with dual door, GPXC series is come with projector cage.

Projector lift positioning adjustment

Upper limit adjustment: Insert the hexagonal adjusting key into the green adjusting hole of the motor
 clockwise: projector lift up counterclockwise: projector lift down.
 Lower lift adjustment: adjustment: Insert the hexagonal adjusting key into the yellow adjusting hole of the motor
 clockwise: projector lift down counterclockwise: projector lift up.

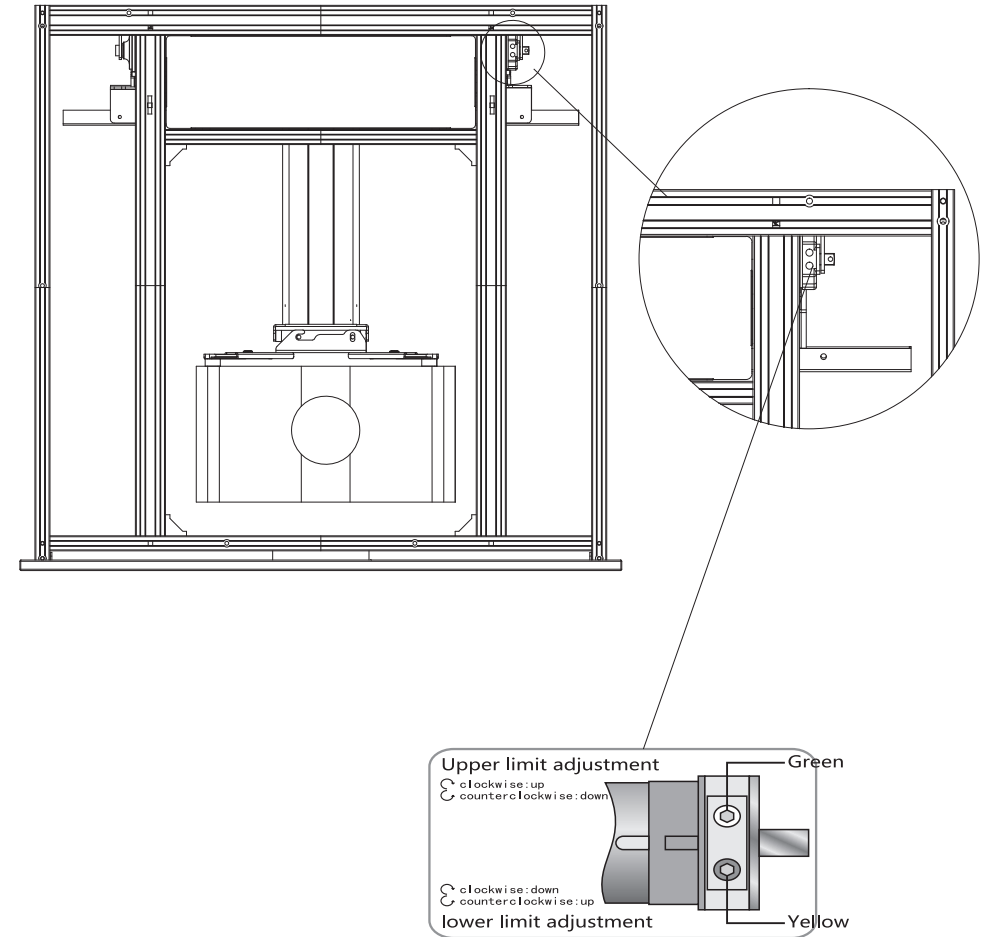

Note: When adjusting the height of the projector lift, insert the adjusting key to adjust the rotation. When rotating, ensure that no less than one and a half turns of the cloth tape is wound on the rotating tube to prevent the cloth tape from falling off; The limit may not be immediately after the limit adjustment It turns out that you must run one or two times to see the difference in positioning position. When the product leaves the factory, it has been adjusted to the best position. If you need to re-adjust, please adjust by professional and technical personnel or contact the manufacturer.

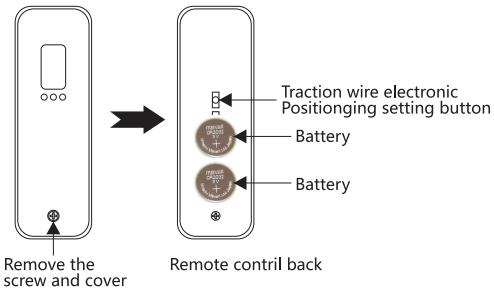

Remote control Notes

1. Working temperature: -20°C to +70°C
2. Battery: 2 pcs of RC2032 button battery
3. Requires replacement battery when given signal weak

Battery installation:

When remote control signal weak, please replace it as following:

1. Remove screw and cover on the back of remote
2. Install battery in correct direction of positive and negative pole according to picture.
3. Reinstall cover and screw

Remote control learning mode

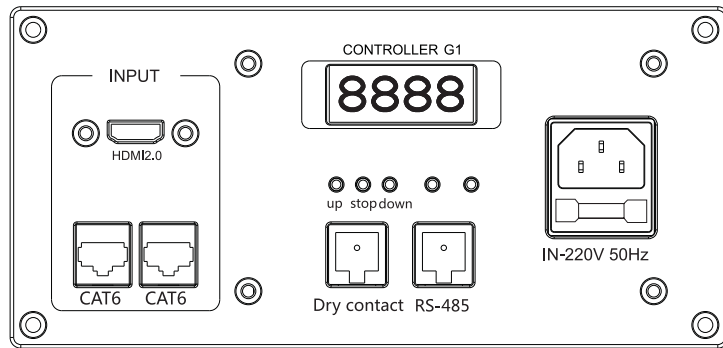

Picture 8

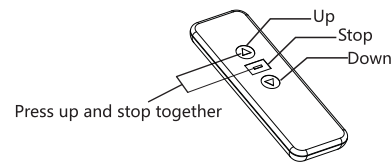

Remote controller pairing instruction:

This product has learning and pairing function. Please enable learning function when first use remote to control the projector lift.

(This product has been paired and learned before EXW)

1. Picture 8, when projector lift is under loading status, long press stop on the control panel within 5 seconds. When number display screen flicker, this product is under learning mode or hold up and stop button for 10 seconds into the study mode.
2. Press up and stop on the remote control until the projector lift slightly moves upwards and downwards.
3. Test if the remote could control the product properly, if not, try to pair again.

Accessories

■ AC097 Remote control	1PCS	■ Certificate	1PCS	■ Warranty card	1PCS
■ Instruction manual	1PCS	■ 4×20 screw	4PCS	■ 5×20 screw	4PCS
■ 4×30 screw	4PCS	■ Φ20×10 black gasket	4PCS	■ Hexagonal key(4mm)	1PCS
■ 5×30 screw	4PCS	■ M4 hexagonal key	1PCS	■ Power cable	1PCS
■ Spring	4PCS	■ M6×35 screw	4PCS	■ Φ6 Gasket	4PCS

Remark: The 3 parts underlined is just for GPXC series.

Specifications

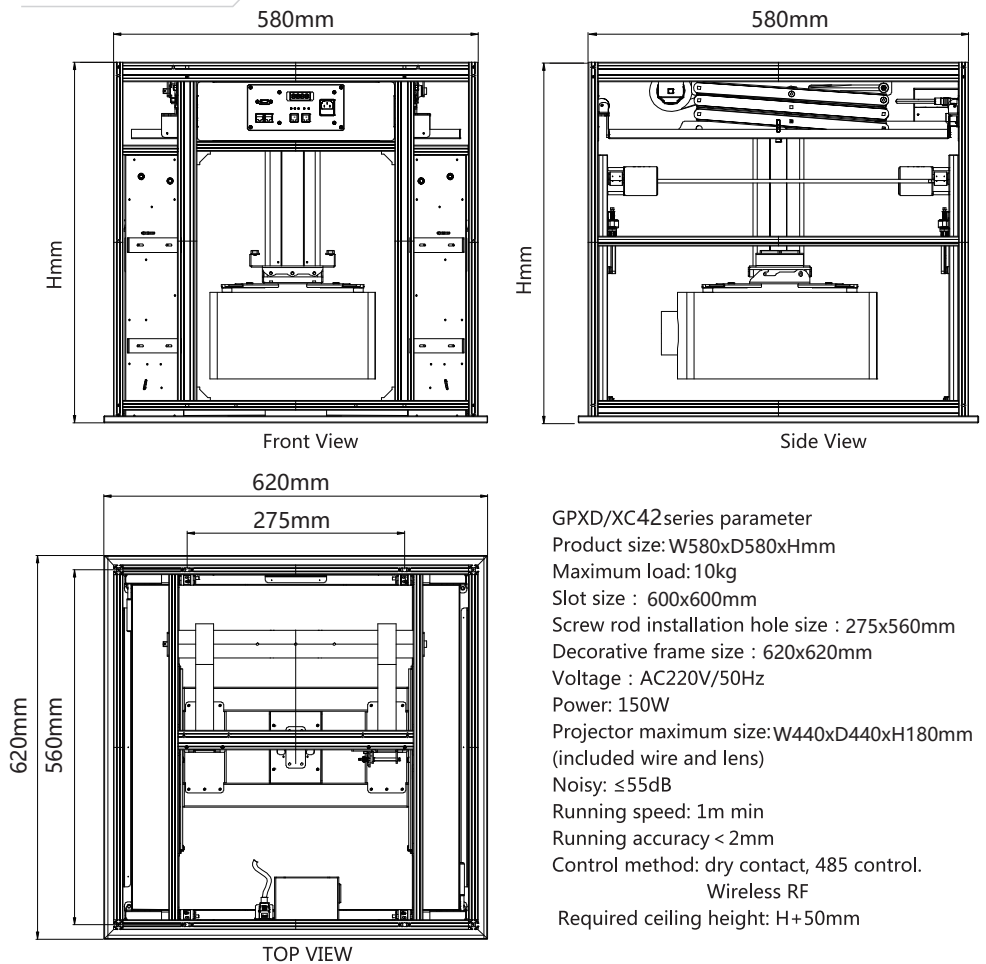

GPXD/XC42 series parameter
 Product size: W580xD580xHmm
 Maximum load: 10kg
 Slot size : 600x600mm
 Screw rod installation hole size : 275x560mm
 Decorative frame size : 620x620mm
 Voltage : AC220V/50Hz
 Power: 150W
 Projector maximum size: W440xD440xH180mm (included wire and lens)
 Noisy: ≤55dB
 Running speed: 1m/min
 Running accuracy < 2mm
 Control method: dry contact, 485 control.
 Wireless RF
 Required ceiling height: H+50mm

Installation

Installation instructions

This projector lift needs to be recessed into the ceiling, and this instruction takes the grille-ceiling as the example. Please install the projector lift according to different application. The projector lift needs to be recessed at the best viewing angle in order to improve the image. Take out all the parts from the packaging and follow the installation instructions as below.

*For the convenience and safety, please read this instruction manual carefully and choose an installation according to your requirement.

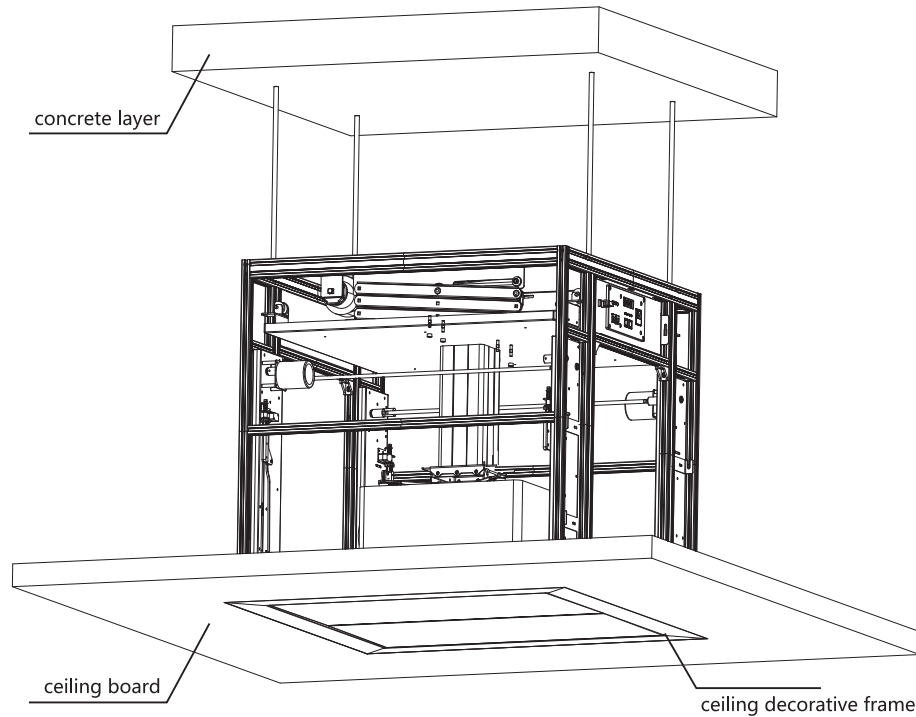

← Projector direction (Note: The opposite direction of the control panel is the projector direction)

Warning: The top plate must be kept parallel when installing, otherwise it will cause damage to the lift.

Rs485 Port Setting :

Bit Rate : 2400 ;
 Data bit : 8 bit ;
 Odd check : N/A ;
 Stopping position : 1

Hexadecimal control code:
 UP:ff,ee,ee,ee,dd
 STOP:ff,ee,ee,ee,cc
 DOWN:ff,ee,ee,ee,ee
 Learn address code instruction:
 if -- -- aa, Can be any character or number, If input ff 11 11 11 aa, It is ff 11 11 11 dd actually, Other codes do the same.

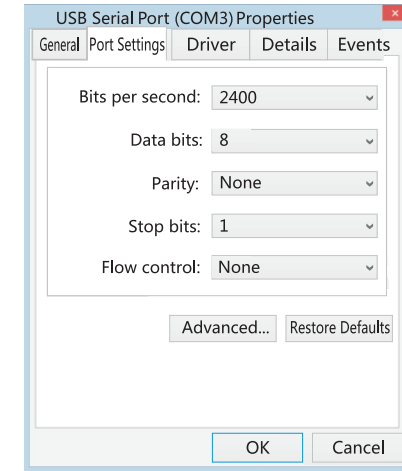

Notice:

1. When connecting via RS232 or RS485, if any control failure, please switch two controlling cable.
2. Connecting Loop Resistance Tester should not be over 20Ω
3. Prohibit parallel line with strong interference source

Remote controller

Control button instruction

1. Press UP to lift
2. Press STOP to stop
3. Press DOWN to lower

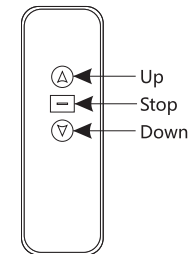

Front View

Dry contact Control Instruction:requires a professional installation or contact

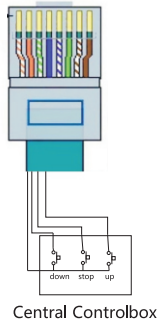

RS-485 plug: 7 + / 8 -



1. orange white
2. orange
3. green white
4. blue
5. blue white
6. green
7. brown white
8. brown

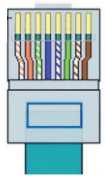

RJ45wiring instruction :

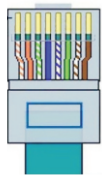

485-RJ45 plug wiring instructor	Central control RJ45 plug wiring instruction
NO.7—485A	NO.1-GND
NO.8-485B	NO.2-DOWN
others Empty	NO.3--STOP
	NO.4-UP
	others Empty

Installation steps

Determine the direction of the projector, the size of the opening and the position of the screw rod:

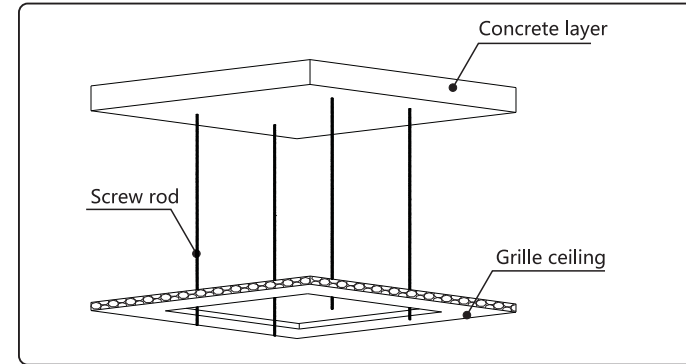

Determine the screw rod installation position at the concrete required installation position (screw rod installation size:275x560mm); drive in the explosion nut, install the M8 screw and tighten it; make a hole on the grille ceiling (opening size:600x600mm)

Note: The opposite side of the control panel is the direction of the projector

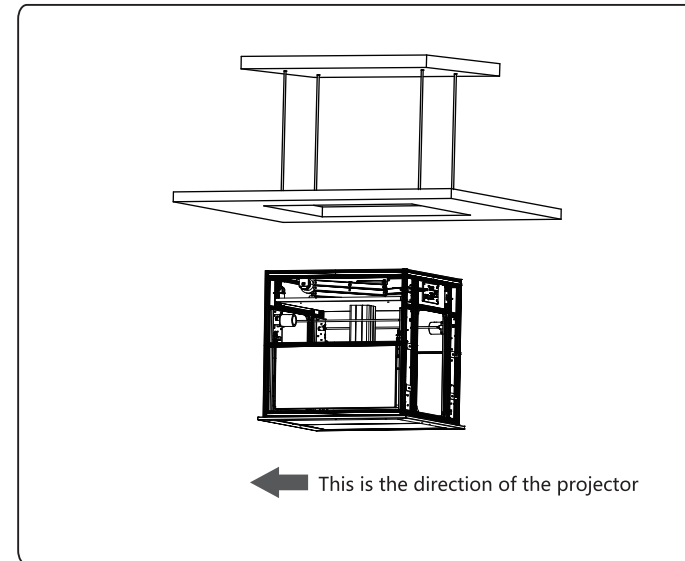

After tightening the screw, align the product at the hole position and pass the screw to the desired position.

Note: The opposite side of the control panel is the direction of the projector

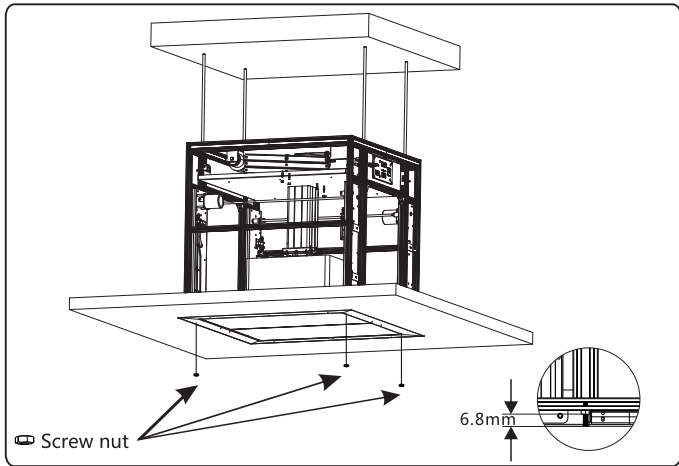

When the product reaches the required height position, tighten with the screw nuts, confirm that the product has been installed firmly, And after the direction of the projector is correct, reserve a 6.8mm-long screw and cut off the excess screw.

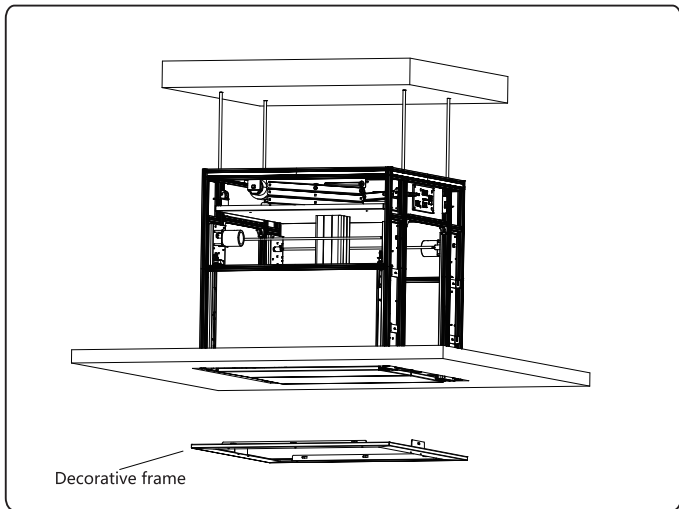

After cutting off the remaining screws, install the ceiling decoration frame, and the installation steps are completed.

⚠ The spirit level on the electric hanger must be adjusted to the level. Tilting will cause the electric hanger to not work normally

If the limit height really needs to be adjusted due to the limitations of the installation environment or site, it must be adjusted by a dedicated technician or contact with after-sales.

Angle adjustment

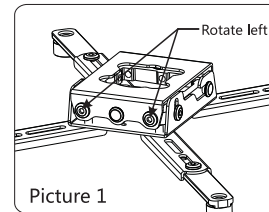

1. Rotate left and right
Use a hex wrench to loosen the two screws on the front end. As shown by the arrow in Figure 1, the universal joint can be adjusted to the left and right by $\pm 3^\circ$.

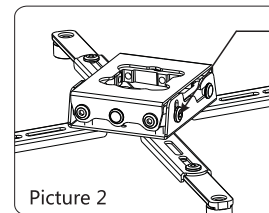

2. Vertical up and down adjustment
As shown in Figure 2, use the hex wrench to loosen the two screws on the left and right. The universal joint can be adjusted vertically upward by 1° and vertically downward by 8° .

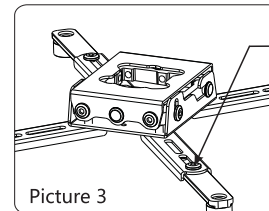

3. The installation foot adjustment
Use a hex wrench to loosen the screws on the mounting feet. As shown in Figure 3, adjust the screws to the desired length and retighten the screws.

Control

Control panel description:

- UP : projector lift up
- STOP: projector lift stop
- DOWN : projector lift down
- Communication port: Category 6 network port
- Dry contact: dry contact interface
- RS485: RS485 interface
- Power input: power input interface
- Reset: long press the UP button, the lift is reset
- HDMI 2.0: 19+1 2.0 HD interface

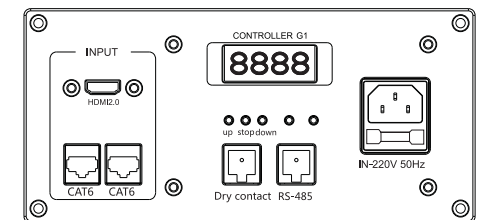

Picture 6