

Details of installation

Height and length adjustment

1. Loosen the positioning screws of low board (2-2), the height of GPCP Main Bar Overview can be adjusted (the maximum height: 45mm) as figure 11.
2. Loosen the positioning screws of main bar (1-4), the length of subsidiary bar (1-3) can be adjusted (check about the data of scope for installation) as figure 12.
3. Loosen the positioning screws of installation board (1-5), the height of installation board (1-5) can be adjusted (the maximum height: 30mm) as figure 13.

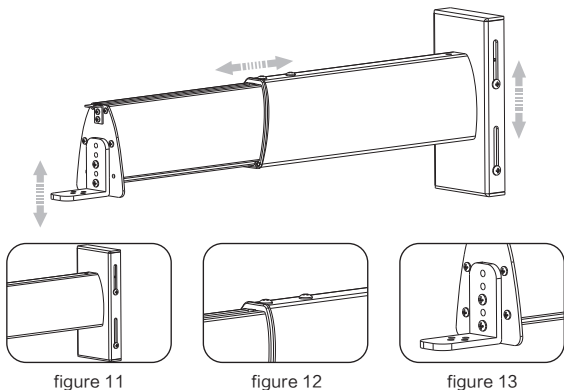

Angle Adjustment

1. Horizontal adjustment: rotate the adjusting button (3-2) for horizontal angle, figure 14
2. Vertical adjustment: rotate the adjusting button (3-3) for vertical angle, figure 15
3. Horizontal rotation adjustment: loosen the rotation adjusting screw (4-2), the installation base can be rotated by 360°; fasten the rotation adjusting screw (4-2) after deciding the angle. figure 16

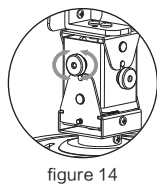

figure 14

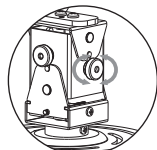

figure 15

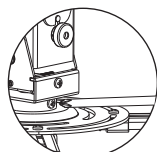
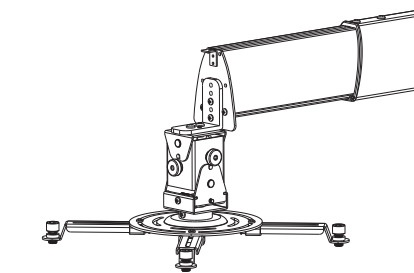

figure 16



The angle of horizontal tilt: $\pm 8^\circ$

The angle of vertical tilt: $\pm 15^\circ$

Rotation: 360°

Installation of main bar

1. Firstly, please confirm how many installation holes the projector has? 3 or 4.
2. Install the required installation arms (4-3) to Installation bracke (4-1) And then, installation arms(4-3) to the projector, and then connect the installation arms (4-3) to the installation base (4-6) However, the installation base needs to be the center of projector. Figure 17
3. Connect the installation arms to the projector conversely if the distance of installation holes is less than 120mm. Connect the installation arms (4-3) to the installation base (4-6) via sliding installation button (4-5) as figure 18
4. Rotate the adjustable nuts (4-4) for adjusting the height of instllation arms (4-2) if the installation holes are not at the same level as figure 19.
5. The front or back of adjuster must be parallel to the surface of projector as figure 20.

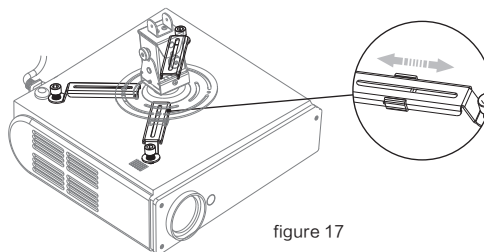

figure 17

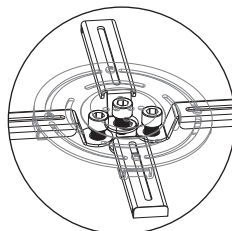

figure 18

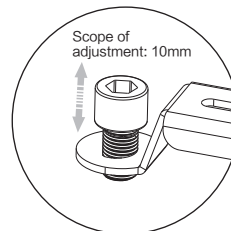

figure 19

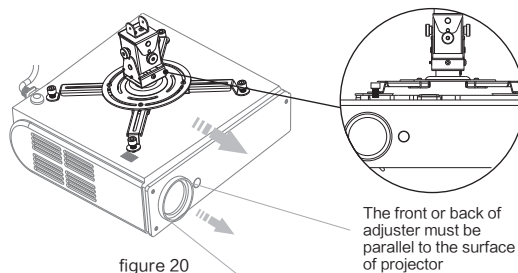

figure 20

The front or back of adjuster must be parallel to the surface of projector

Grandview®

Instruction Manual

Projector Wall Mount

Applicable Model
GPCP-E4060
GPCP-E6090
GPCP-E90150

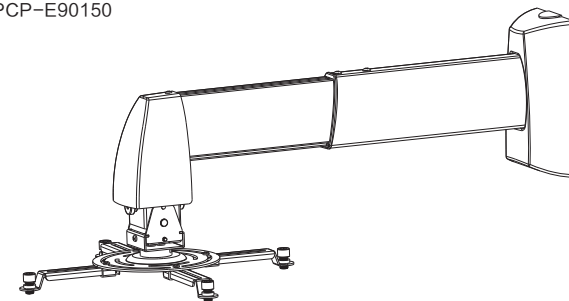

Please read before using

Thank you for purchasing our products. Please read the instruction manual carefully in order to ensure this projector lift is suitable for your projection equipment.

Cautious

Warnings For safety, the minimum weight of ceiling must be 20Kg

Weight The maximum weight of installation bracket is 20Kg (note: the installation bracket's maximum weight of GPCP-E90150 is 15kg)

Caution Please do not incline the projector the extremely.

Do not take apart Please do not take apart the accessories of projector ceiling mount.

Grandview Crystal Screen Canada Ltd.

#11- 3751 North Fraser Way,
Marine Way Business Centre,
Burnaby, BC, Canada V5J 5G4
Tel: 1-604-412-9777 Fax: 1-604-412-9796
Website: www.grandviewscreen.ca

Guangzhou Grandview Crystal Screen Co., Ltd.

No.43,Guomao Road South, Hualong Town,
Panyu District, Guangzhou City, China
Tel: +8620-8489-9499 Fax: +8620-8480-3343
Website: www.grandviewscreen.com
www.grandviewscreen.com.cn

Parts

GPCP-E is combined by GPCP and GPE

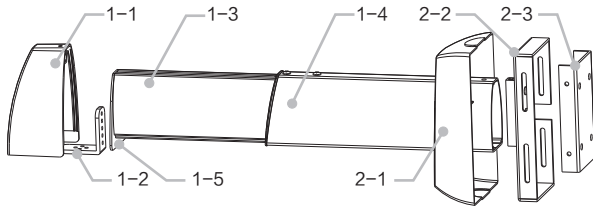

GPCP Main Bar Overview

- 1-1 Top Cap
- 1-2 Front Board
- 1-3 Subsidiary Bar
- 1-4 Main Bar
- 1-5 Installation Board
- 2-1 Low Cap
- 2-2 Low Board
- 2-3 Fixation

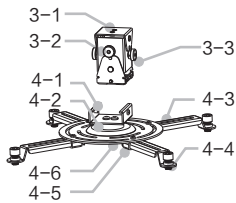

GPD Adjustment Overview

- 3-1 Adjuster
- 3-2 Horizontal Adjusting Button
- 3-3 Vertical Adjusting Button
- 4-1 Installation Bracket
- 4-2 Rotation Adjusting Screw
- 4-3 Installation Arm
- 4-4 Adjustable Nut
- 4-5 Sliding Installation Button
- 4-6 Installation Base

Accessories

- ① M3X30 Philips Screw (4pcs)
- ② M4X30 Philips Screw (4pcs)
- ③ M5X30 Philips Screw (4pcs)
- ④ M5X8 Philips Screw (4pcs)
- ⑤ M6X12 Anti-Slip Screw (2pcs)
- ⑥ M5X10 Philips Screw (7pcs)
- ⑦ M6X25 Tapping Screw (4sets)
- ⑧ Ø6X50 Wood Screw (4sets)

Scope

Scope for installation (Installation hole of projector):

Maximum scope for installation: 345mm diameter

Minimum scope for installation: 45mm diameter

Note: Connect the installation arms to the projector conversely for different installation holes of projector.

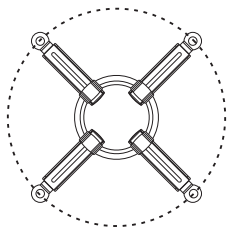

Maximum diameter: 345mm

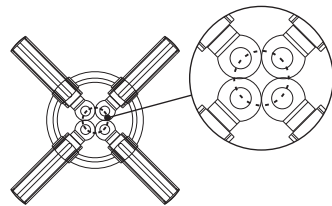

Minimum diameter: 45mm

Scope

Scope for installation (H is the distance between ceiling and projector)

The H of GPCP-E4060 is 420mm~600mm

The H of GPCP-E6090 is 600mm~900mm

The H of GPCP-E90150 is 900mm~1500mm

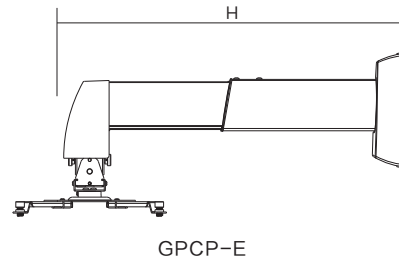

Steps of installation

- 1 Firstly, collect the power wires to the main bar as figure 1. Invaginate the low cap to the main bar as figure 2. Install the low board to the main bar, and then fasten the screws (accessories 5) as figure 3. Finally, install the front board to the front board, and then fasten the screws (accessories 6) as figure 4.

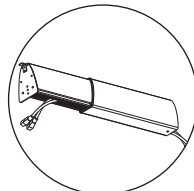

figure 1

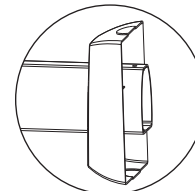

figure 2

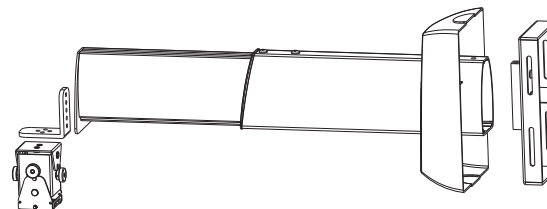

figure 3

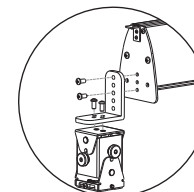

figure 4

Steps of installation

- 2 Install the fixation on the wall (choose the screws according to the materials of wall, Use the screw of accessory 7 for concrete-wall, and use the screw of accessory 8 for wood-wall) as figure 5. And then, install the Main Bar Overview to the fixation and fasten the screws (accessory 5). Finally, connect the GPE Adjusting Overview to the adjuster and then fasten the screws (accessory 6) as figure 7.

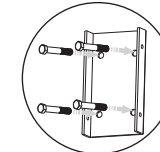

figure 5

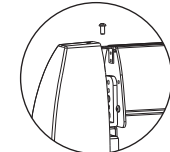

figure 7

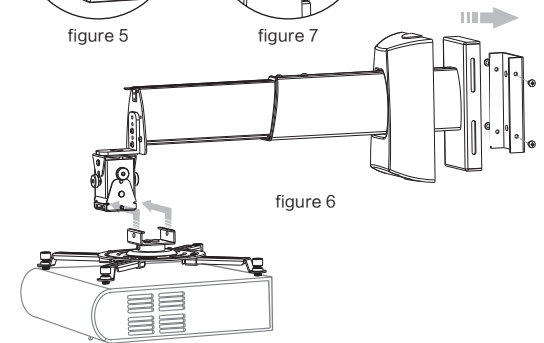

figure 6

Details of installation

Wires collection

Loosen out the positioning screws of main bar (1-4) as figure 8, and then take apart subsidiary bar (1-3) from main bar (1-4). Put the wires into the main bar (1-4) then insert the wires to the plastic groove of subsidiary bar (1-3). And then, re-install the subsidiary bar (1-3) to main bar (1-4) after collecting the wires as figure 9-10.

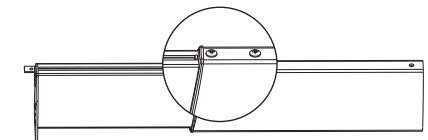

figure 8

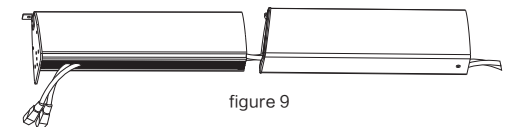

figure 9

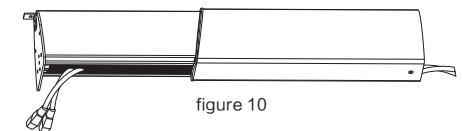

figure 10