

Details of installation

Wires collection

Take apart the ornament cap of main bar (2-5) after connecting the GPCM Main Bar Overview to the fixation (1-1), then stay the power cord into the storage gap. At last, re-install the ornament cap of main bar (2-5) as figure 6、7 and 8.

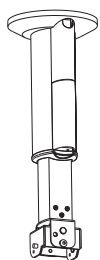

figure 6

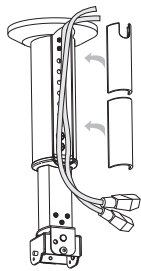

figure 7

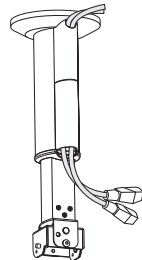

figure 8

Height Adjustment

Take apart the ornament cap of main bar (2-3) and loosen the front positioning screws. Adjust the subsidiary bar (2-3) to required position, and then install the ornament cap of main bar (2-3) as figure 9 (the main bar of GPCM-D3040 is separated by 8 segments, each segment is 16mm; the main bar of GPCM-D4060 is separated by 15 segments, each segment is 16mm)

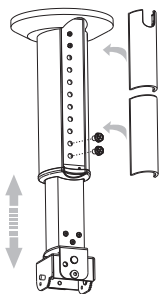

figure 9

Angle Adjustment

1.Looseen the positioning screws (front and back) for adjusting the angle, and then rotate the screwdriver for fine turning to the required angle as figure 10.

2.Looseen the positioning screws (left and right) for adjusting the angle, and then rotate the screwdriver for fine turning to the required angle as figure 11.

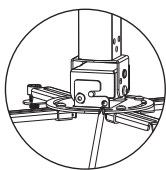

figure 10



The angle of vertical tilt: $\pm 15^\circ$

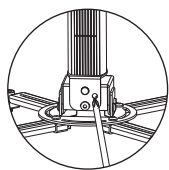

figure 11



The angle of horizontal tilt: $\pm 5^\circ$

Installation of main bar

1.Firstly, please confirm how many installation holes the projector has? 3 or 4.

2.If there are 3 holes, the installation arms (4-2) need to be taken apart from Installation bracket firstly. Connect 3 installation arms(4-2) to the projector, and then connect the installation arms (4-2) to the installation base (4-5) However,the installation base needs to be the center of projector. Figure 12.

3.Connect the installation arms to the projector conversely if the distance of installation holes is less than 120mm. Connect the installation arms (4-2) to the installation base (4-5) via sliding installation button (4-4) as figure 13

4.Rotate the adjustable nuts (4-3) for adjusting the height of installation arms (4-2) if the installation holes are not at the same level as figure 14.

5.The front or back of adjuster must be parallel to the surface of projector as figure 15.

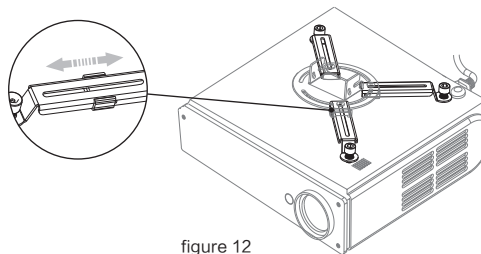

figure 12

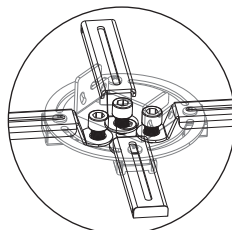

figure 13

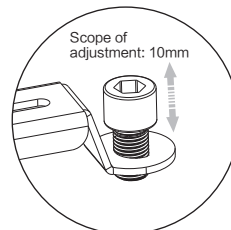

figure 14

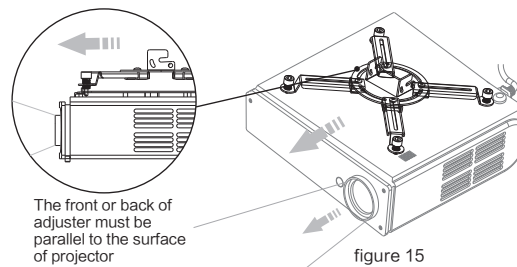

figure 15

The front or back of adjuster must be parallel to the surface of projector

Grandview Crystal Screen Canada Ltd.

#11- 3751 North Fraser Way,
Marine Way Business Centre,
Burnaby, BC, Canada V5J 5G4
Tel: 1-604-412-9777 Fax: 1-604-412-9796
Website: www.grandviewscreen.ca

Guangzhou Grandview Crystal Screen Co., Ltd.

No.43,Guomao Road South, Hualong Town,
Panyu District, Guangzhou City, China
Tel: +8620-8489-9499 Fax: +8620-8480-3343
Website: www.grandviewscreen.com
www.grandviewscreen.com.cn

Grandview®

Instruction Manual

Projector Ceiling Mount

Applicable Model
GPCM-D3040
GPCM-D4060
GPCM-D600

Please read before using

Thank you for purchasing our products. Please read the instruction manual carefully in order to ensure this projector lift is suitable for your projection equipment.

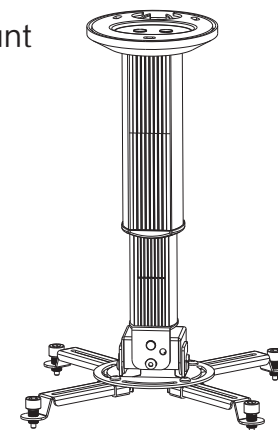

Cautious

 **Warnings** For safety, the minimum weight of ceiling must be 20KG

 **Weight** The maximum weight of installation bracket is 20Kg

 **Caution** Please do not incline the projector the extremely.

 **Do not take apart** Please do not take apart the accessories of projector ceiling mount.

Parts

GPCM-D is combined by GPCM and GPD

GPCM Main Bar Overview

- 1-1 Fixation
- 1-2 Top Cap
- 2-1 Main Bar
- 2-2 Subsidiary Bar
- 2-3 Ornament Board of Main Bar
- 2-4 Ornament Board of Subsidiary Bar
- 2-5 Ornament Cap of Main Bar

GPD Adjusting Overview

- 3-1 Adjuster
- 3-2 Hanging Button
- 3-3 Horizontal Adjusting Hole
- 4-1 Installation Bracket
- 4-2 Installation Arm
- 4-3 Adjustable Nut
- 4-4 Sliding Installation Button
- 4-5 Installation Base
- 4-6 Vertical Adjusting Button

Accessories:

- ① M6x25 Tapping Screw (3sets)
- ② M5x10 Philips Screw/Washer/Spring Washer (4sets)
- ③ M4x8 Socket Cap Screw (6pcs)
- ④ M5x8 Philips Screw (2pcs)
- ⑤ M3x30 Philips Screw (4pcs)
- ⑥ M4x30 Philips Screw (4pcs)
- ⑦ M5x30 Philips Screw (4pcs)

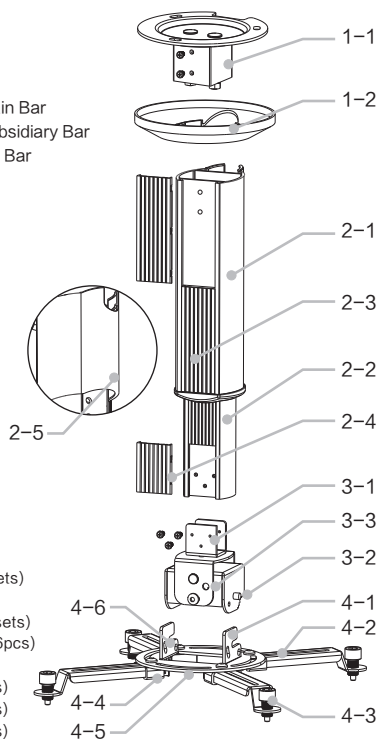

Scope

Scope for installation (H is the distance between ceiling and projector)

The H of GPCM-D3040 is 300mm~400mm

The H of GPCM-D4060 is 400mm~600mm

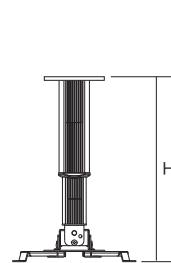

GPCM-D3040

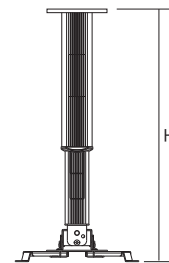

GPCM-D4060

Three steps of installation

- ① Install the fixation on the ceiling (screws of accessory ①) as figure 1. GPCM-D can be installed to the concrete-roof with ceiling or without ceiling, such as figure 2 and figure 3.

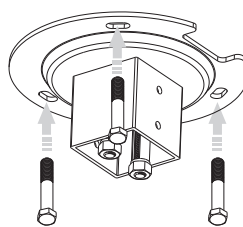

figure 1

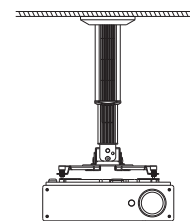

figure 2

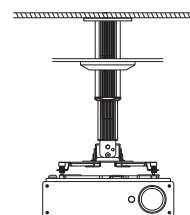

figure 3

Three steps of installation

- ② Connect the GPCM Main Bar Overview to the fixation (screws of accessory ②). Store the power wire, and then fasten the front and back screws of main bar. Finally, install the ornament board of main bar as figure 4.

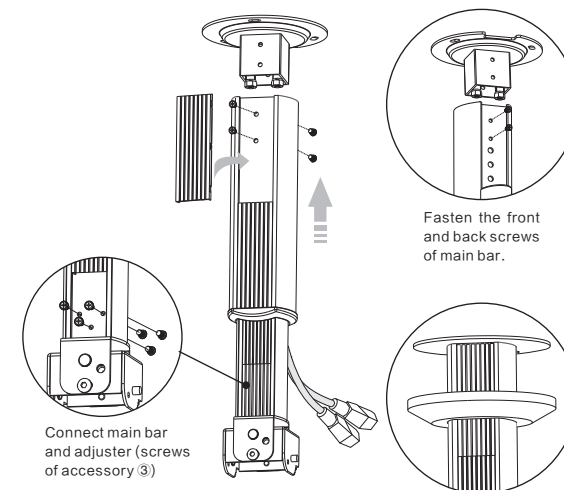

figure 4

- ③ Hang the installation bracket (projector has been installed) to the adjuster as figure 5. And then put in the screws (accessory ④), but do not faster.

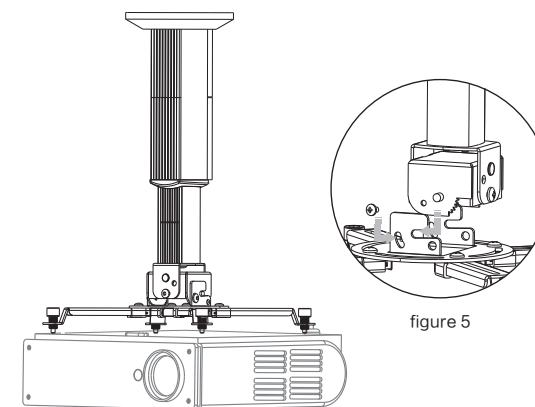

figure 5

Scope

Scope for installation (Installation hole of projector):

Maximum scope for installation: 310mm diameter

Minimum scope for installation: 40mm diameter

Note: Connect the installation arms to the projector conversely for different installation holes of projector.

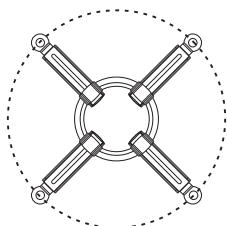

Maximum diameter: 310mm

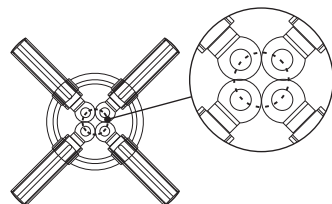

Minimum diameter: 40mm