

A. Please install GPC support bar assembly on the ceiling

1. Fix the base on the ceiling or concrete (please ensure that the load is 40kg at least). Figure 7
2. Open the back ornament board ③ b, and loosen the screws of subsidiary arm④ . Please adjust the subsidiary arm④ to your desired position (this function is only for B200、B300), and then fasten the screws again. Please hide the power line into the gap and close the back ornament board ③ b. Figure 9 and Figure10.

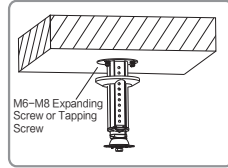

Figure 7

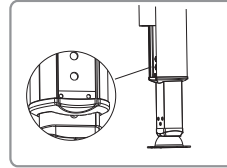

Figure 8

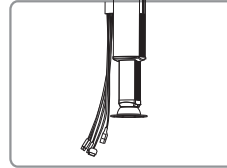

Figure 9

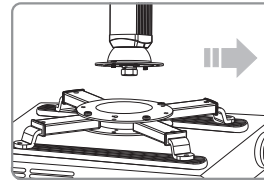

Figure 10

B. Please connect the GPC support bar assembly and GPM projector fixation

1. According to figure 10 and figure 11, please adjust the groove of half-cycle junction to be consistent with the direction of the projector. The positioning bar of GPC half-cycle junction must be align to the groove of GPC projector fixation, and then circumrotate for fastening. Finally, connect GPC half-cycle junction⑤ and GPC projector fixation using with two M4x5 pressing screws.
2. Please ensure whether the GPC projector fixation is fastened.
3. Connection of power cord to projector.
4. Install the back ornament board.

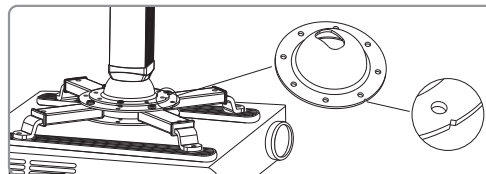

Figure 11

C. Adjust your desired angle.

1. Loosen the screws of GPC support bar assembly⑥ via the spanned; adjust the projector to your desired position and fasten it. Figure 12
2. The direction of projector can be adjusted by forward 30° and backward 3° . Left and right adjustment is 3° . Figure 13.

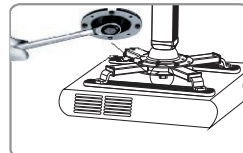

Figure 12

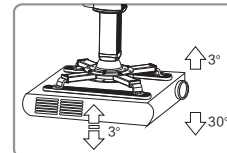

Figure 13

Grandview®

Instruction Manual

Projector Lift GPCM-B

Applicable Model:GPCM-B Series

Please read before using

Thank you for purchasing our products. Please read the instruction manual carefully in order to ensure this projector lift is suitable for your projection equipment.

This projector lift must be installed for the bottom of projector (bottom area: length is 280mm; width is 255mm). (Figure: suitable area for projector lift)

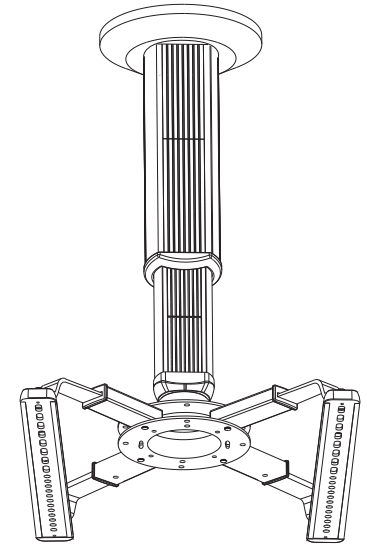

Cautious

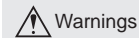

Warnings

This instruction manual is written for dealers and technicians.

The customer must employ the technicians for installation. Please process the construction following this instruction manual to avoid injury caused by accidents.

For safety, the minimum load of ceiling must be 40KG

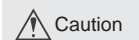

Caution

Please do not incline the projector the extremely.



Do not take apart

Please do not take apart the accessories of projector lift.

Grandview Crystal Screen Canada Ltd.

#11- 3751 North Fraser Way,
Marine Way Business Centre,
Burnaby, BC, Canada V5J 5G4
Tel: 1-604-412-9777 Fax: 1-604-412-9796
Website: www.grandviewscreen.ca

Guangzhou Grandview Crystal Screen Co., Ltd.

No.43,Guomao Road South, Hualong Town,
Panyu District, Guangzhou City, China
Tel: +8620-8489-9499 Fax: +8620-8480-3343
Website: www.grandviewscreen.com
www.grandviewscreen.com.cn

Diagram for applicable projector area

This projector lift must be installed on the bottom of projector (length 240mm; width 255mm). Figure 1. Note: there is a spot of insatllation , figure 2.

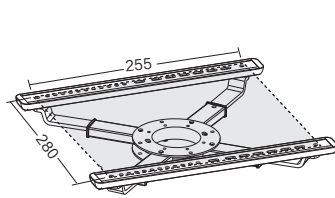

Figure 1

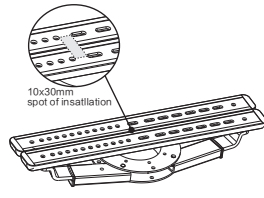
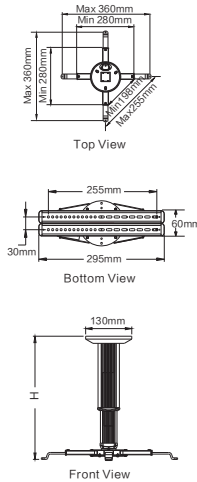
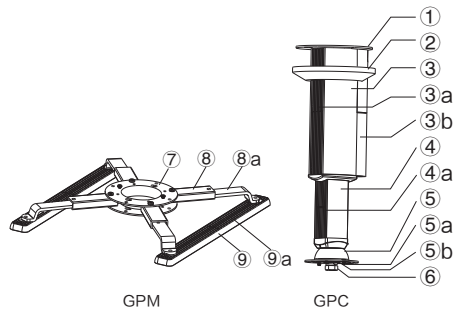

Figure 2



Components and Accessories

GPCM-B is combined by GPC and GPM .



GPM

GPC

Specifications

Model	GPCM-B	
Adjust distance for each grid	/	16
Specifications for Multifunctional Arm	30x295	
The length of main arm a	70	
The length of subsidiary arm a	50	
Load	25kg	

Optional Accessories(Support Bar, Multifunctional Arm)

Product Name	Specifications
The length of support bar	400/600/800
Specification for Multifunctional Arm	30x355

Parts:

- ① Base (1pc)
- ② Ornament Cover (1pc)
- ③ Main Bar (1pc)
- ③a Front Ornament Board
- ③b Back Ornament Board
- ④ Subsidiary Bar(1pc)
- ④a Ornament board for subsidiary bar
- ⑤ Half-Cycle Junction (1pc)
- ⑤a Positioning Screw (2pcs)
- ⑤b Glider (1pc)
- ⑥ Main Screw (1pc)
- ⑦ Main Fixation (1pc)
- ⑧ Main Arm (4pcs)
- ⑧a Subsidiary Arm (4pcs)
- ⑨ Multifunctional Arm (2pcs)
- ⑨a Ornament board for Multifunctional Arm(4pcs)

Accessories

- M4x10 Pressing Screw (4pcs)
- M4x5 Pressing Screw (2pcs)
- M3x10 Cross Machine Screw(4pcs)
- M4x10 Cross Machine Screw(4pcs)
- M5x10 Cross Machine Screw(8pcs)
- M5x30 Cross Machine Screw(4pcs)
- M3x20 Cross Machine Screw(4pcs)
- M4x20 Cross Machine Screw(4pcs)
- M5x20 Cross Machine Screw(4pcs)
- M3x30 Cross Machine Screw(4pcs)
- M4x30 Cross Machine Screw(4pcs)
- M5 Self-tapping Screw(3pcs)
- ∅ 16x10 Rubber Insert(4pcs)
- ∅ Washer(4pcs)
- ∅ Spring Washer(4pcs)
- Spanner (1pc)

GPC

1. Assembly

The main bar③ and the subsidiary bar④ are fixed together from factory. And the positioning bar is installed on half-cycle junction⑤b. Before installation, please put the half-cycle junction⑤ on subsidiary bar④. Please put the glider ⑤b on the half-cycle junction⑤, and then fasten the screw.

2. Adjustment

Loosen the screens of main bar③ and subsidiary bar④. The distance between projector and ceiling can be adjusted according to the distance of install holes between main bar③ and subsidiary bar④. Please refer to H in specification table.
(Note: GPCM-B100 is no subsidiary bar and no stretch function).

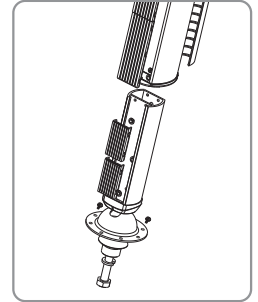

GPM

Usage

- If need, please loosen the screws on the main arm⑧ and subsidiary arm⑧a to extend the arms.
- Please follow figure 4 or figure 5 to install the multifunctional arm, because of different projectors. In addition, the multifunctional arm can be invisible from the projector.
- Put the main fixation⑦ on projector at the central gravity. Make sure the two ∩ holes on the main fixation⑦ locate at the both side.
- Before connecting GPC main bar③, please fasten the screws of main arm⑧ and subsidiary arm⑧a.

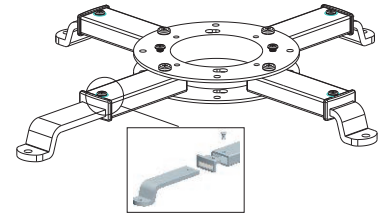

Figure 3

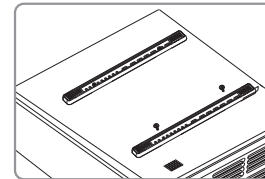

Figure 4

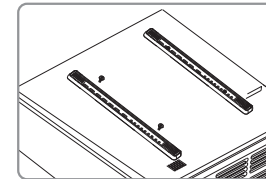

Figure 5

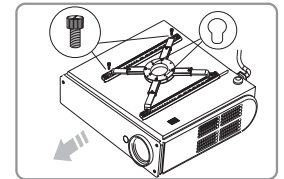
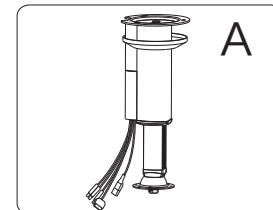
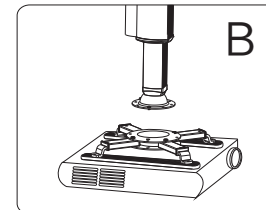

Figure 6

Three steps for installation



A. Please install GPC support bar assembly on the ceiling



B. Please connect the GPC support bar assembly and GPM projector fixation

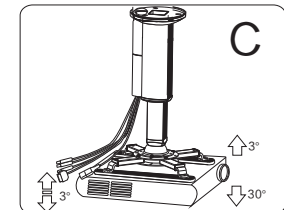

C. Adjust your desired angle.